

RoHS Compliance

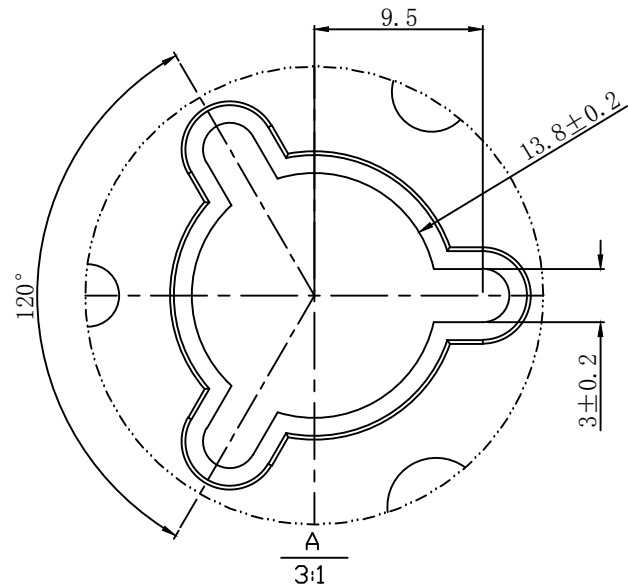
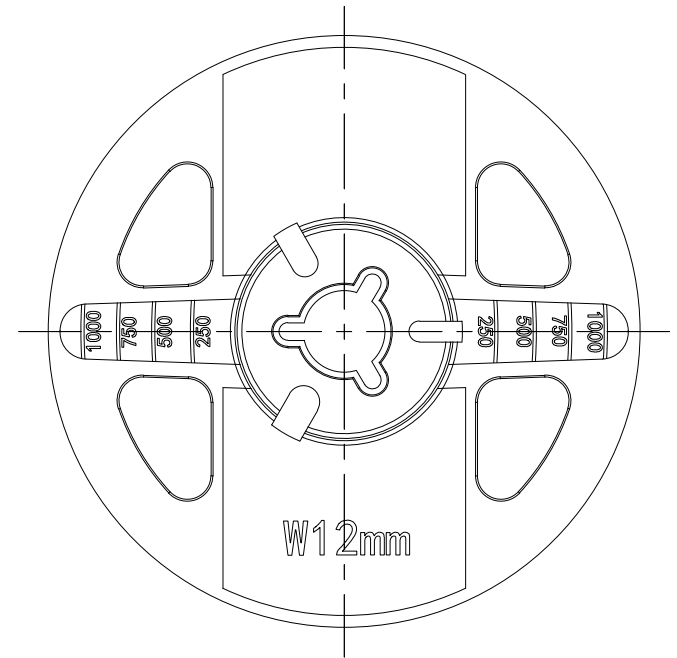
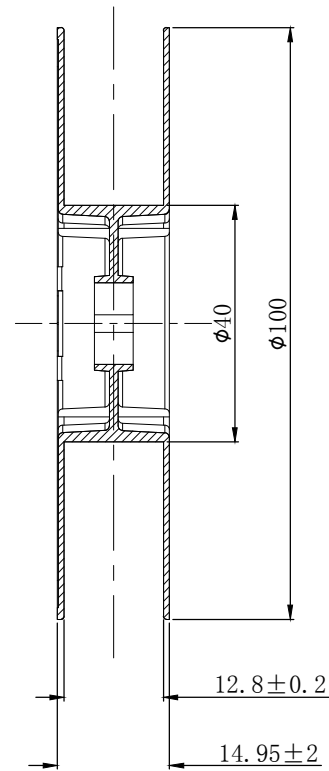
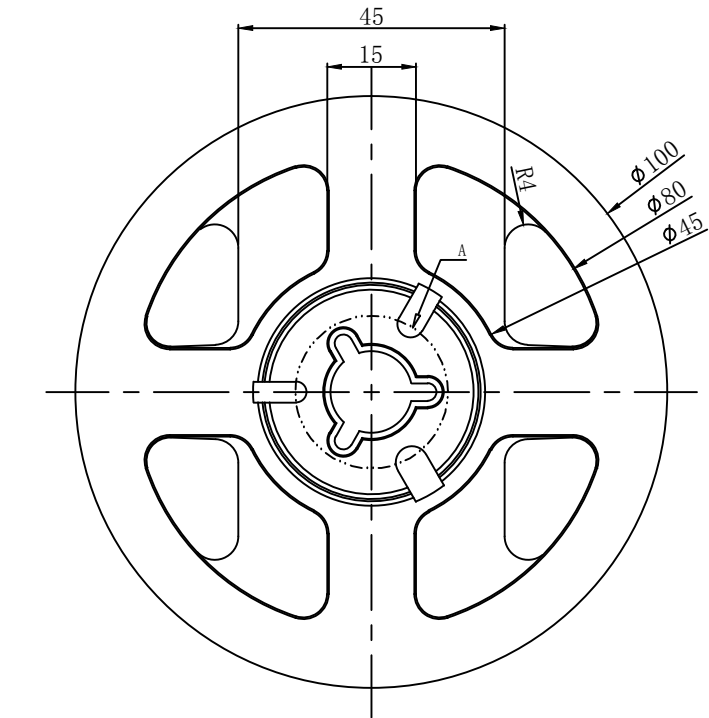

SINHO ELECTRONIC TECHNOLOGY CO.,LTD				
Item	SHPR0412	Color	Black	
Size	4"*12mm	Materials	HIPS	
Tool No.	/	Unit	MM	
Approved	YU		Made by	ZHOU